

РЕВЕРСИВНЫЙ НАСОС - СЕРИИ XV

XV-1R

**ВАЛ ЦИЛИНДРИЧЕСКИЙ
ФЛАНЕЦ Ø50,8 ТИП "SAE AA"**

X 1 R 25 61 В В В Е

Серия	X	Серия XV
Группа	1	Группа 1
Категория	R	Ревверсивный насос
Рабочий объем	25	3,8
Фланец	61	Ø50,8 Тип "SAE AA" с реверсивным вращением
Вал	B	C1002- Вал цилиндрический ø12,7, шпонка.3,2 мм
Корпус	Вход	Входной канал - 3/8" GAS
	Выход	Выходной канал - 3/8" GAS
Крышка	E	Со сливом 1/4" BSP



XR168

Таблица технических характеристик

ТИП	Раб. Об. См³/об	Макс. Давление		КОД																	
		P1 бар	P3 бар	Внешний слив								Внутренний слив									
				X	1	R	16	61	B	B	B	E	X	1	R	16	61	B	B	B	F
XV-1R/0.9	0,91	240	280	X	1	R	16	61	B	B	B	E	X	1	R	16	61	B	B	B	F
XV-1R/1.2	1,17	250	290	X	1	R	17	61	B	B	B	E	X	1	R	17	61	B	B	B	F
XV-1R/1.7	1,56	250	290	X	1	R	18	61	B	B	B	E	X	1	R	18	61	B	B	B	F
XV-1R/2.2	2,08	250	290	X	1	R	20	61	B	B	B	E	X	1	R	20	61	B	B	B	F
XV-1R/2.6	2,60	250	300	X	1	R	21	61	B	B	B	E	X	1	R	21	61	B	B	B	F
XV-1R/3.2	3,12	250	300	X	1	R	23	61	B	B	B	E	X	1	R	23	61	B	B	B	F
XV-1R/3.8	3,64	250	300	X	1	R	25	61	B	B	B	E	X	1	R	25	61	B	B	B	F
XV-1R/4.3	4,16	250	300	X	1	R	27	61	B	B	B	E	X	1	R	27	61	B	B	B	F
XV-1R/4.9	4,94	250	300	X	1	R	29	61	B	B	B	E	X	1	R	29	61	B	B	B	F
XV-1R/5.9	5,85	250	300	X	1	R	31	61	B	B	B	E	X	1	R	31	61	B	B	B	F
XV-1R/6.5	6,50	250	300	X	1	R	32	61	B	B	B	E	X	1	R	32	61	B	B	B	F
XV-1R/7.8	7,54	220	260	X	1	R	34	61	B	B	B	E	X	1	R	34	61	B	B	B	F
XV-1R/9.8	9,88	190	230	X	1	R	36	61	B	B	B	E	X	1	R	36	61	B	B	B	F

P1) Макс. рабочее давление - P3) Макс. пиковое давление

Для работы насоса в тяжелом режиме рекомендуется проверять допустимый крутящий момент на валу.

Таблица габаритов

ТИП	Вес кг	A мм	B мм	C мм	D	
					ВХОД	ВЫХОД
XV-1R/0.9	1,000	82,6	41,8	70,6	3/8" BSPP	3/8" BSPP
XV-1R/1.2	1,020	83,5	42,3	71,5	3/8" BSPP	3/8" BSPP
XV-1R/1.7	1,060	85,0	43,0	73,0	3/8" BSPP	3/8" BSPP
XV-1R/2.2	1,080	87,0	44,0	75,0	3/8" BSPP	3/8" BSPP
XV-1R/2.6	1,110	89,0	45,0	77,0	3/8" BSPP	3/8" BSPP
XV-1R/3.2	1,140	91,0	46,0	79,0	3/8" BSPP	3/8" BSPP
XV-1R/3.8	1,170	93,0	47,0	81,0	3/8" BSPP	3/8" BSPP
XV-1R/4.3	1,220	95,0	48,0	83,0	3/8" BSPP	3/8" BSPP
XV-1R/4.9	1,250	98,0	49,5	86,0	3/8" BSPP	3/8" BSPP
XV-1R/5.9	1,310	101,5	51,3	89,5	3/8" BSPP	3/8" BSPP
XV-1R/6.5	1,350	105,0	52,5	93,0	3/8" BSPP	3/8" BSPP
XV-1R/7.8	1,410	108,0	54,5	96,0	3/8" BSPP	3/8" BSPP
XV-1R/9.8	1,550	117,0	59,0	105,0	3/8" BSPP	3/8" BSPP

T.1 = 24.5±29.4 [Н·м] - крутящий момент затяжки винтов M8



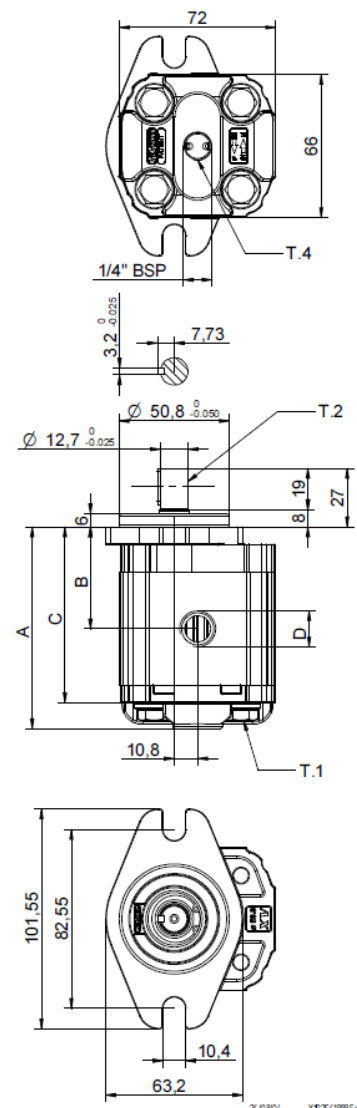

T.2 = 32,8 [Н·м] - допустимый крутящий момент на валу

(Примечание: Выбирая вал, всегда проверяйте допустимый крутящий момент).

T.4 = 0,3±0,5 бар - максимальное давление на сливе.

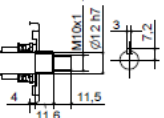
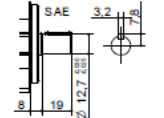
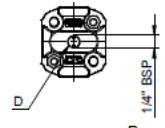
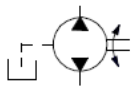
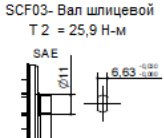
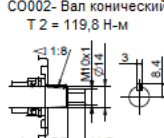

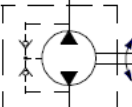
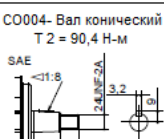
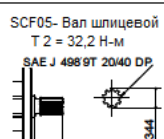
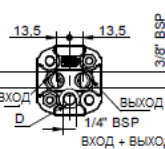
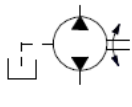
ФЛАНЕЦ Ø50,8 ТИП "SAE AA"

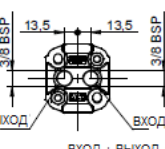
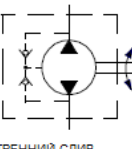
Фланец Ø50,8 Тип "SAE AA"		Вал				Крышка			
	61	CI001- Вал цилиндрический T 2 = 25,8 Н-м 	A	CI002- Вал цилиндрический T 2 = 32,8 Н-м 	B			E	
		SCF03- Вал шлицевой T 2 = 25,9 Н-м 	E	CO002- Вал конический T 2 = 119,8 Н-м 	G			F	
		CO004- Вал конический T 2 = 90,4 Н-м 	I	SCF05- Вал шлицевой T 2 = 32,2 Н-м 	K			K	
		CO002-НК- Вал конический T 2 = 119,8 Н-м 	O	CI001-НК- Вал цилиндрический T 2 = 25,8 Н-м 	P			L	
						Внешний Слив			
						Внутренний Слив			
						ВХОД + ВЫХОД + ВНЕШНИЙ СЛИВ			
						ВХОД + ВЫХОД + ВНУТРЕННИЙ СЛИВ			

Типоразмер	
ТИП	КОД
XV-1R/0.9	16
XV-1R/1.2	17
XV-1R/1.7	18
XV-1R/2.2	20
XV-1R/2.6	21
XV-1R/3.2	23
XV-1R/3.8	25
XV-1R/4.3	27
XV-1R/4.9	29
XV-1R/5.9	31
XV-1R/6.5	32
XV-1R/7.8	34
XV-1R/9.8	36

Стандартные корпуса				
Рабочий Объем См ³ /об	Стандартные резьбы			
	0.9	I-I	B-B	J-J
1.2	I-I	B-B	J-J	Z-Z
1.7	I-I	B-B	J-J	Z-Z
2.2	I-I	B-B	J-J	Z-Z
2.6	I-I	B-B	J-J	Z-Z
3.2	I-I	B-B	J-J	Z-Z
3.8	I-I	B-B	J-J	Z-Z
4.3	I-I	B-B	J-J	Z-Z
4.9	I-I	B-B	J-J	Z-Z
5.9	I-I	B-B	J-J	Z-Z
6.5	I-I	B-B	J-J	Z-Z
7.8	I-I	B-B	J-J	Z-Z
9.8	I-I	B-B	J-J	Z-Z

В таблице указаны имеющиеся в ассортименте комбинации стандартных фланцев и резьб.

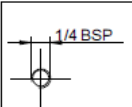
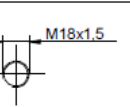
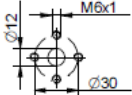
Корпус (резьбы/фланцы)													
	A		B		C		D		E		F		G
	H		I		J	Закрытый Корпус	Z						